



INSTALLATION INSTRUCTIONS FOR PART 95-8211

APPLICATIONS

Toyota Avalon 2000-2004

95-8211

KIT FEATURES

- Double DIN Radio Provision
- Stacked ISO Mount Units Provision



KIT COMPONENTS

- A) Double DIN Trim Plate

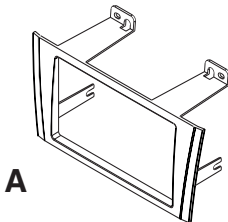

A

TOOLS REQUIRED:

- Small Flat Blade Screwdriver
- Panel Removal Tool
- Phillips Screwdriver
- Socket Set



1-800-221-0932



www.metraonline.com

© COPYRIGHT 2004 METRA ELECTRONICS CORPORATION



TABLE OF CONTENTS

Dash Disassembly

- *Toyota Avalon 2000-2004 (column shift models) 1*
- *Toyota Avalon 2000-2004 (console shift models) 2*

Kit Assembly

- *Double DIN Radio Provision 3*
- *Stacked ISO Mount Units Provision 4*

Final Assembly 5

***Note:**

Refer also to the instructions included with the aftermarket radio.

TOYOTA AVALON 2000-2004 (column shift models)

**Note: Refer also to the instructions included with the aftermarket radio.*

- 1 Disconnect the negative battery-terminal to prevent an accidental short circuit.
- 2 Unsnap the trim below the climate control to reveal (2) 10 MM bolts and remove. (Figure A)
- 3 Carefully pull air vents above radio towards rear of car to unsnap. **NOTE:** There are (3) snaps, (2) are at the bottom sides and (1) is at the top middle of the vent assembly. (Figure B)
- 4 Remove (2) 10 MM bolts from above radio/climate control assembly. Unplug and remove assembly together. (Figure C)
- 5 Remove (6) Phillips screws (4 from radio and 2 from climate control) from each side bracket to separate radio and climate control. (Save climate controls and brackets to reuse during kit assembly). (Figure D)

Continue to kit assembly.

A

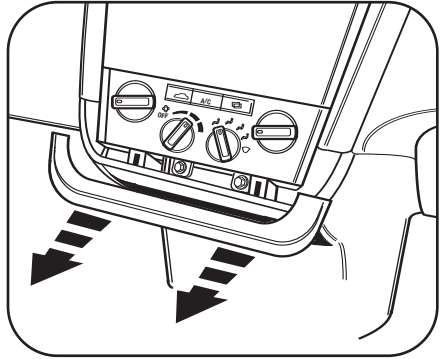

B

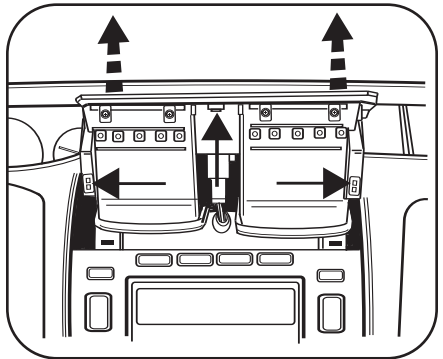

C

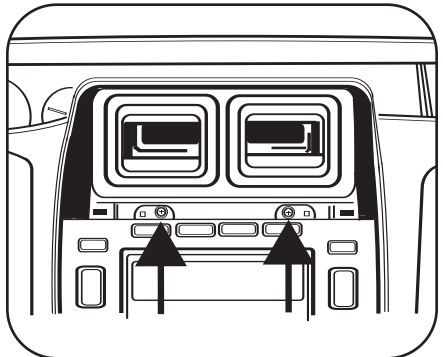

D

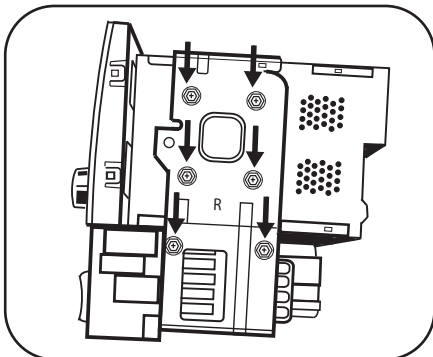

TOYOTA AVALON 2000-2004 (console shift models)

**Note: Refer also to the instructions included with the aftermarket radio.*

- 1 Disconnect the negative battery terminal to prevent an accidental short circuit.
- 2 Open the center console armrest, unsnap cover above cup holder and remove (2) Phillips screws toward the outside of the panel. (Figure A)
- 3 Lift up and remove shifter trim/ash-tray assembly. (Figure B)
- 4 Unsnap black cover from under climate controls and remove (2) 10 MM bolts. (Figure C)
- 5 Carefully pull air vents above radio towards rear of car to unsnap. **NOTE:** There are (3) snaps, (2) are at the bottom sides and (1) is at the top middle of the vent assembly. (Figure D)
- 6 Remove (2) 10 MM bolts from above radio/climate control assembly. Unplug and remove assembly together. (Figure E)
- 7 Remove (6) Phillips screws (4 from radio and 2 from climate control) from each side bracket to separate radio and climate control. (Save climate controls and brackets to reuse during kit assembly). (Figure F)

Continue to kit assembly.

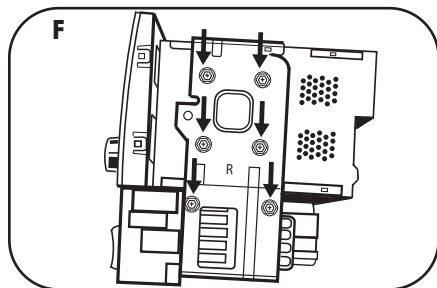
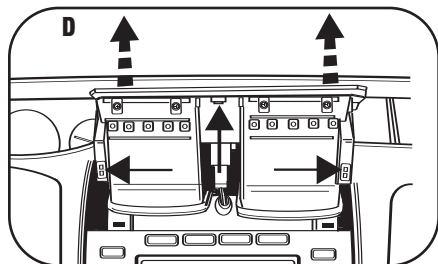
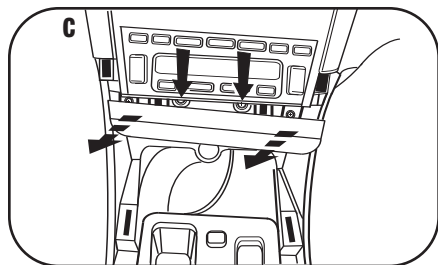
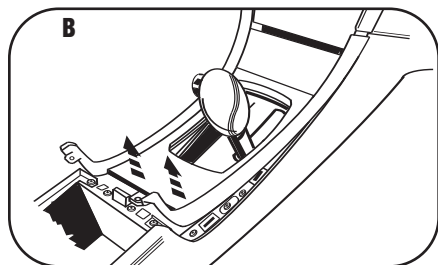
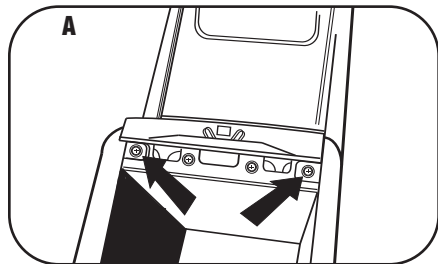

DOUBLE DIN RADIO PROVISION

**Note: Refer also to the instructions included with the aftermarket radio.*

- 1 Attach the factory mounting brackets and the Double DIN trim plate to the Double DIN radio using the screws supplied with the radio. (Figure A)

Continue to final assembly.

A

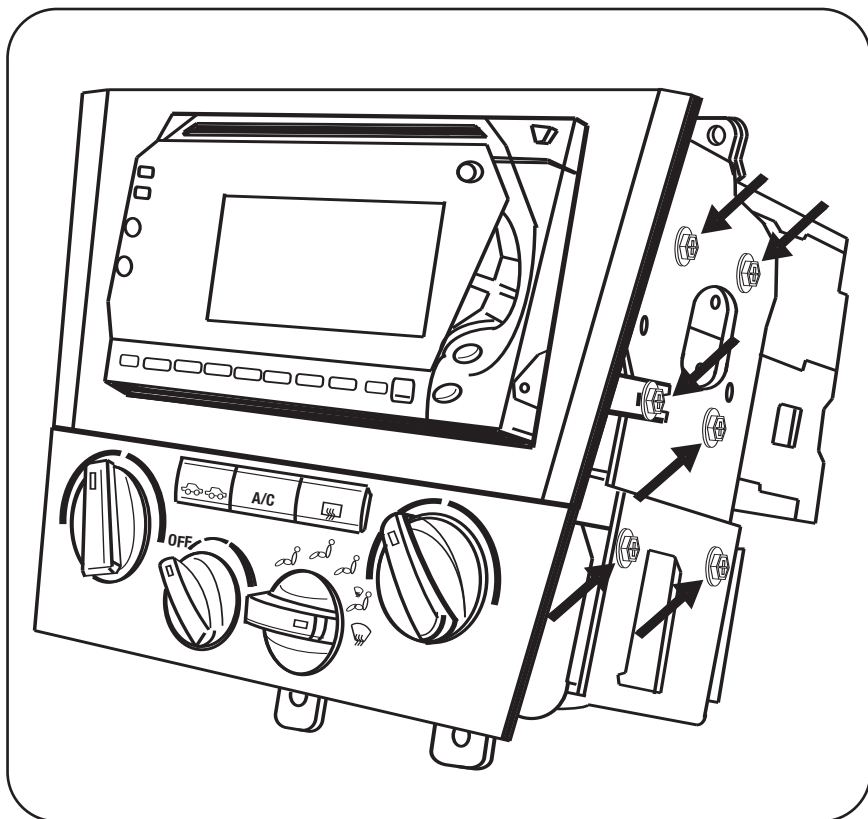

STACKED ISO MOUNT UNITS PROVISION

**Note: Refer also to the instructions included with the aftermarket radio.*

- 1 Attach the factory mounting brackets and the Double DIN trim plate to the stacked ISO Mount units using the screws supplied with the units. (Figure A)

Continue to final assembly.

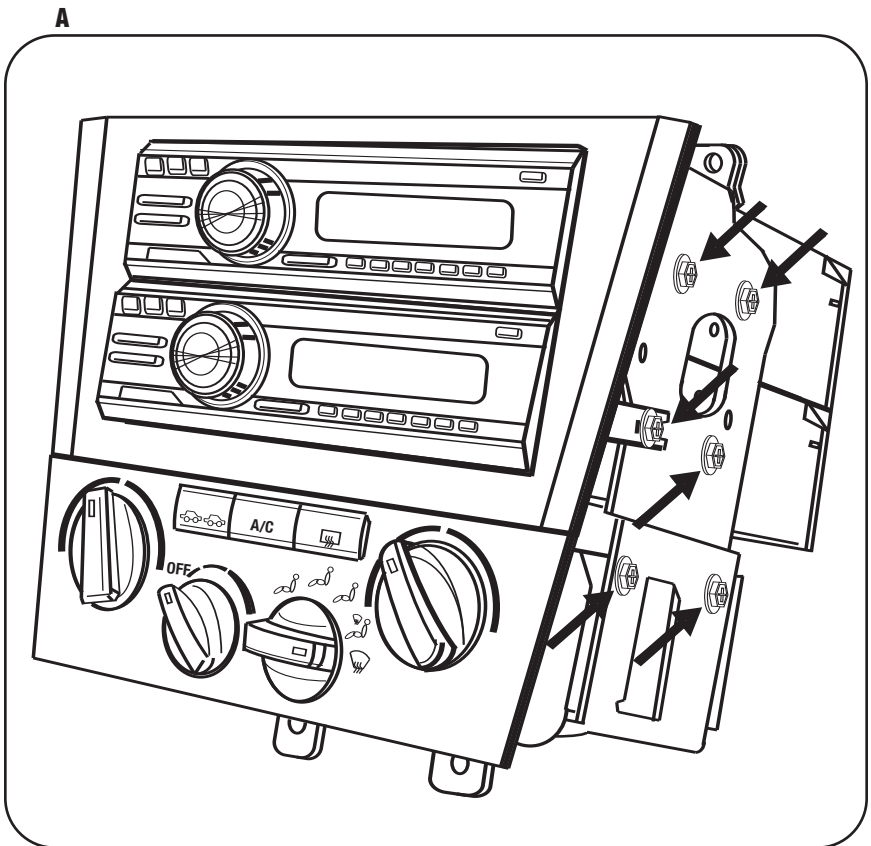

FINAL ASSEMBLY

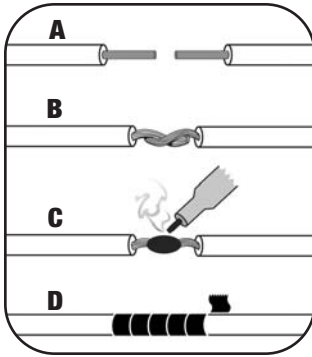

(A) Strip wire ends back 1/2"

(B) Twist ends together

(C) Solder

(D) Tape

- 1** Locate the factory wiring harness in the dash. Metra recommends using the proper mating adapter and making connections as shown. (Isolate and individually tape off the ends of any unused wires to prevent electrical short circuit.)
- 2** Re-connect the negative battery terminal and test the unit for proper operation.
- 3** Reassemble radio and dash assemblies in reverse order of disassembly.

FINAL WIRING CONNECTIONS

Make wiring connections using the EIA color code chart shown below and the instructions included with the head unit. Metra recommends making connections as shown below; Strip, Splice, Solder, Tape. Isolate and individually tape off ends of any unused wires to prevent electrical short circuit.

METRA / EIA WIRING CODE

| | |
|------------------------------------|---|
| 12V Ignition / Acc. Red | Right Front (+) Gray |
| 12V Batt / Memory Yellow | Right Front (-) Gray / Black |
| Ground Black* | Left Front (+) White |
| Power Antenna Blue | Left Front (-) White / Black |
| Amp Turn-On Blue / White | Right Rear (+) Violet |
| Amp Ground Black / White | Right Rear (-) Violet / Black |
| Illumination Orange | Left Rear (+) Green |
| Dimmer Orange / White | Left Rear (-) Green / Black |

***NOTE:** When a Black wire is not present, ground radio to vehicle chassis.
All colors may not be present on all leads due to manufacturer's specifications.

95-8211 INSTRUCTIONS



1-800-221-0932



www.metraonline.com

REV. 01/03/07 © COPYRIGHT 2004 METRA ELECTRONICS CORPORATION

INST95-8211